

Mold Markings:

Jacket Marking:
 UL, CSA

Mold Markings:

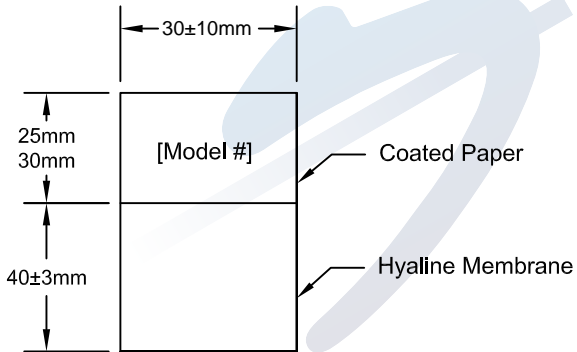

Packing: Bundled to Ease Installation

No.	Specification	QTY	Remarks	UL File No.	Approved	Date	StayOnline®				
1	SJT 18 AWG/3 105° C° BLACK	1PC		E250704 E257089 E115330 E152635 E72389	Checked	Date		Customer			
2	Plug IEC 60320 C14 BLACK	1PC			Drawn	Date	15SEP2020	Model #	PFC1418E48		
3	Connector IEC 60320 C13 BLACK	1PC			Item No.	8261		Material	PVC	Units	mm
4	LABEL: (40+30) * 30 mm	1PC	MAX Length = 73mm		Drawing No.		Rev.	A	Scale		